

## “Hermosa”

Johnny “JR” Richards

Years ago, I did a design I named “Vermillion” using the paper cone SB Acoustics drivers. It was very well received, and a friend expressed an interest in purchasing them from me. At the time I needed the money so down the road they went. The name was simultaneously a nod to my youth (a local lake was named Vermillion, and it was the last name of a family I grew up across from. They had a family band and were my introduction into how cool live rock and roll can be) as well as the color I settled on for the plywood cabinets.

That design represented a couple of firsts for me. Significantly, it was the first design I did that used a faceted baffle. It is my opinion this is what contributed to the imaging characteristics of the design. I have wanted to do a similar design for quite some time, but I just never got around to doing it.

This particular design started taking shape when a friend gifted me a pair of poly cone SBA drivers. I spent the better part of the day trying to figure out what I was going to do with them – specifically which tweeter I had or was willing to purchase to pair with them. I had just used the little SB dimple dome tweeter – and was thoroughly impressed with its performance so I was considering using them in a small but higher-end design similar to the Vermillion.

However, the very next day another friend gifted me a pair of Hiquphon OW1. One of them had been turned down to a 90MM and the other to 92MM outside diameter but were otherwise new. The only caveat was that I had to use them in a design and publish said design. The tweeters for my project had been found. I always wanted to use the Hiq tweeters but found them to be cost prohibitive – this was an unexpected gift and I was truly grateful for both of my friends and their generosity.

I spent some time playing in modeling software trying to come up with the right alignment for the poly woofers but backburned this design for awhile as it was winter and I had a few designs that were in process at the time. I needed to finish those before starting this one. In the interim, Madisound put the paper cone version of the woofer on sale for \$44 and remembering how much I enjoyed the sound of the paper cone in the Vermillion I grabbed a pair. At the time I never made the connection that these should be used in the design I was doing as a tribute to one of my personal favorite designs – I just saw a good deal and jumped on it. Several days later it came to me that these should be used in place of the poly.

Next step was to finalize a bass alignment and begin the process of designing the cabinets. Over the years I have discovered that I am fond of baffles that appear to be dominated by the drivers. Most of the designs I keep for personal use fit that aesthetic, so that was a determining factor on baffle size. Another factor driving baffle size was I was intent on faceting these, so needed a little extra “meat” on the baffle.

I fired up my 22 year old version of Autocad (it runs fine on Win11, by the way. I have run this copy on every version of Windows with the exception of Win8 since Windows 98SE days) and started tinkering. I eventually settled on a baffle size of 8-1/2” by 11-1/2”. This gave me room to run facets down either side

as well as hitting the “baffle full of drivers” aesthetic. I also like the somewhat “squat” look it yielded – makes them appear beefy.

Net internal volume in the original model ended up being around 0.3 cubic feet tuned to the high 30’s yielding a predicted F3 of 49Hz. I do my modeling with series resistance added as that can change things dramatically. In this case I used 0.8 ohm added resistance as a ballpark. This modeling yielded this response:

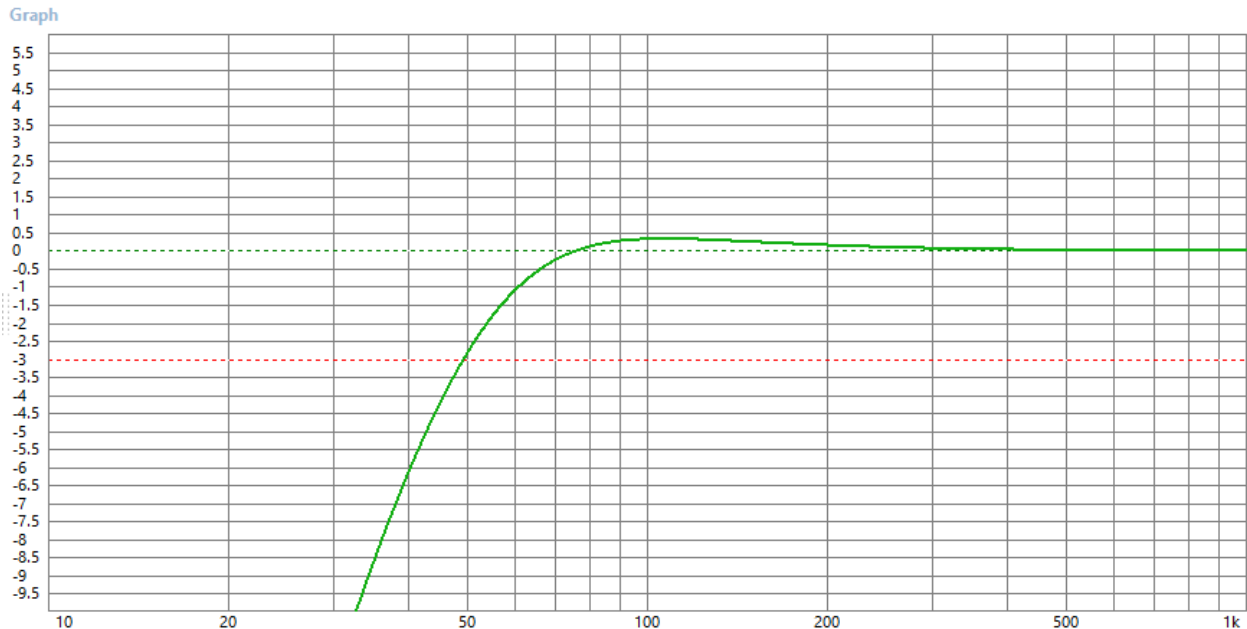

However, one problem presented itself with this model. I wanted to use a 2” port for reasons (namely I had several pair of 2” ports on the shelf), but the required length ended up being unwieldy in the cabinet size I decided on. It would require a port tube nearly 18” in length to tune this sized cabinet to the required frequency! As a compromise - and possibly a serious one at that - I ended up tuning quite a bit higher than ideal at 55Hz. This yields a ripple of 3db at 75Hz and a F3 of 52Hz.

Whatever distance from ideal this may be, I also know that extra energy in the 70-80hz range can lead to the impression of more bass than is being physically reproduced *and* it is similar to a sealed design with a highish Q. This region is also fun to emphasize since it is in what I call the “fun range” – kick drums, bass guitars, etc. Is it ideal and audiophile flat? Of course not – but I believe the compromise to be one that trades absolute accuracy for a fun “kick in the pants” kind of sound.

However – there is a solution to the “problem of the too-long port” (that kind of sounds like the title of a Sherlock Holmes short, doesn’t it?) and that is a passive radiator. Passive radiators offer some advantages over a port anyways, and depending on brand are not overly expensive to buy. In this case, I modeled several options and settled on the aluminum cone 6.5” from Dayton’s Designer Series.

I was pleasantly surprised at how well it models – and how simple the implementation would be. This is the first passive radiator design I have tinkered with that did not require excessive amount of weight to be added – it is almost as if it were tailor designed for this woofer in this box.

With zero added weight, the model indicates an F3 of 54Hz with a 1.4db ripple centered around 78Hz. It sacrifices a bit of extension for flatness – the benefit of which is going to arguably become more about preference in the bass region.

Here is the compromised alignment I ended up using (note the 1db division):

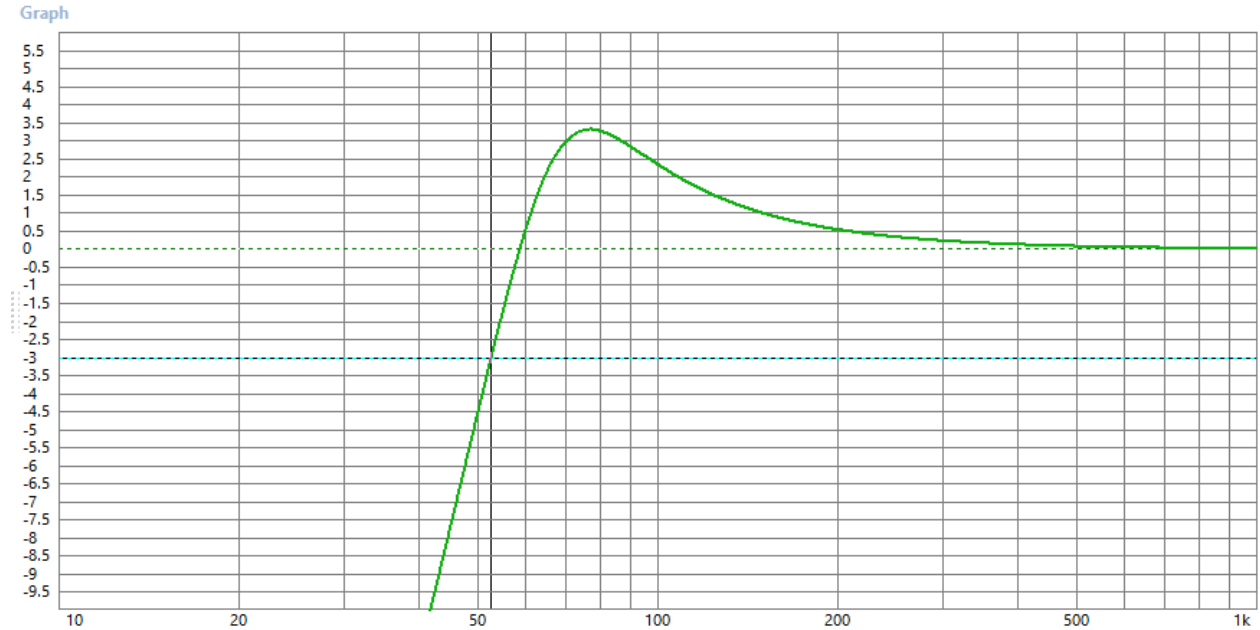

And here is the passive radiator model:

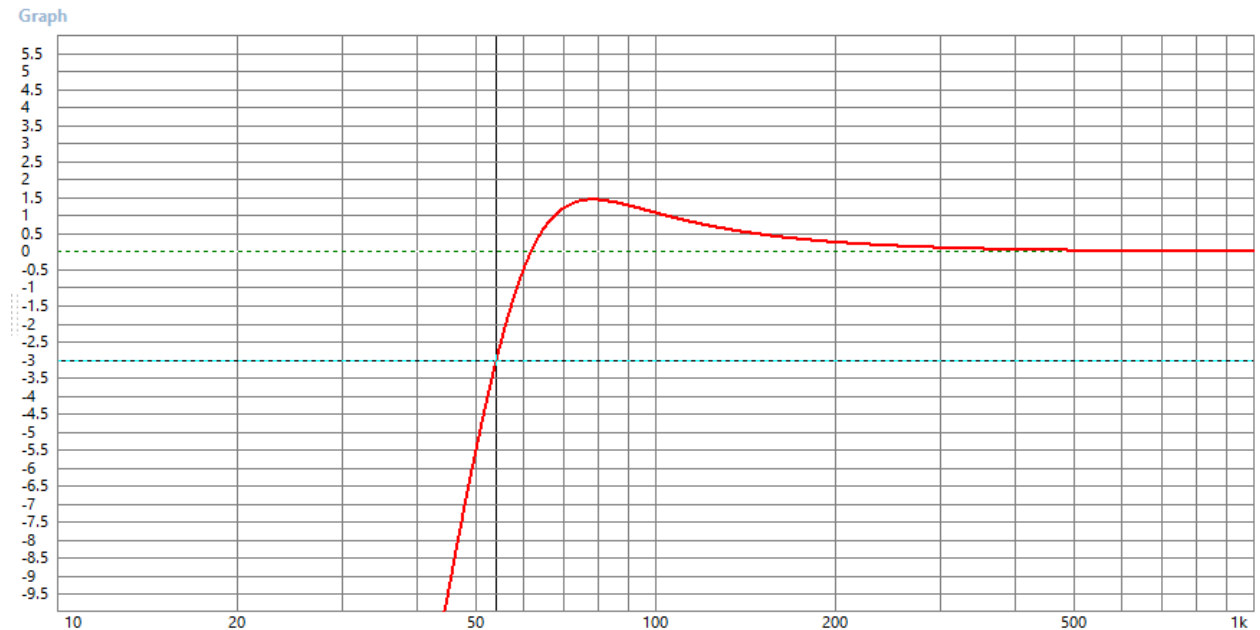

If you are contemplating building these, consider purchasing a pair of the passive radiators from Parts Express. As of this writing they are only \$22 each and in my opinion the best way to proceed with this design.

Adding a bit of mass to the PR to extend F3 is also a possibility. Adding 20 grams removes the slight peak at 78Hz and extends F3 to 50Hz:

Graph

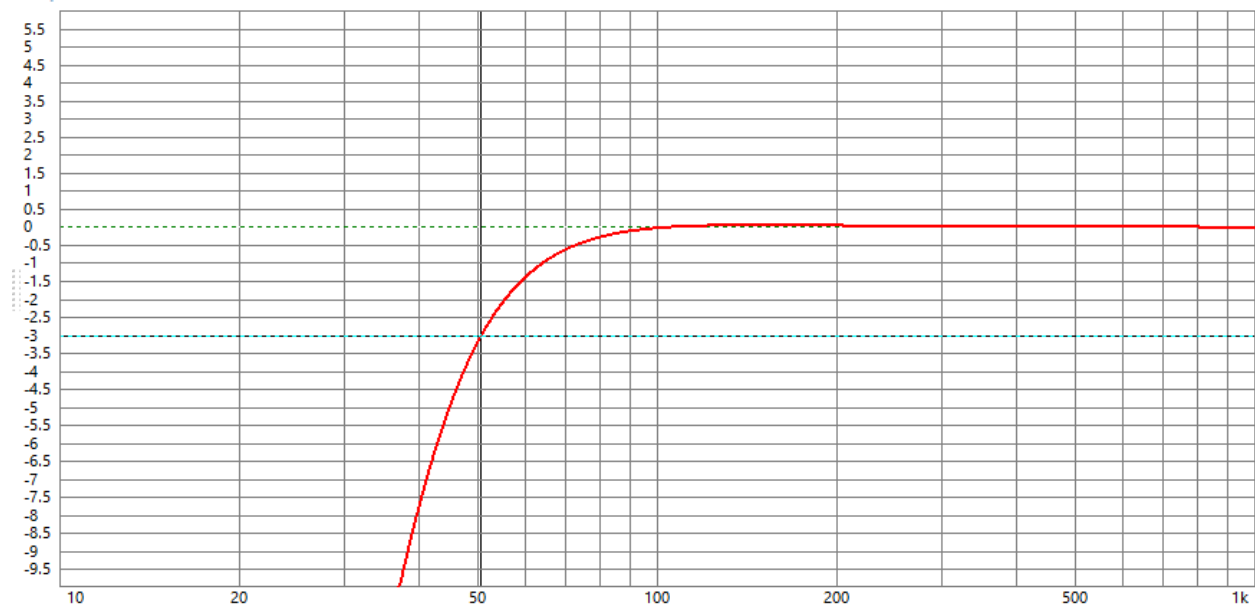

I use particle board these days for several reasons. One: it is affordable – and that matters this day and age. Two: it dusts up in a fashion that is much easier to clean up. Three: it is generally stiffer than an equivalent thickness of MDF. Drawbacks are it can be less homogenous than MDF, chips out along the edge easier, and the end grain is an absolute nightmare to finish off. I rarely finish my cabinets these days and really do not worry about the varying density that may be present so I use the PB.

I currently use the budget priced PB shelving from Menards due to it costing around \$3 for a what amounts to a 1/8 sheet of 3/4" PB. That is a killer price – but there are some caveats to these. Sometimes they are not in stock when you need them, there can be variances in size that you have to be aware of, some of them have what looks like a very small rabbit cut along the long side. Bring your eyes and a tape measure and you will be fine.

However, for the baffles on smaller speakers these days I have been using the PB stair tread from Menards. This stuff is incredible. 1-1/8" thick and stiff, stiff, stiff. It is also hard as a rock for the first 1/8" on either side so just beware when hitting it with the router bit. If you bear down too much on the first and last pass when cutting rebates you may find out there is a lot of smoke hiding in that PB.

I use the thick stair treads because I do not do anything less than a 1" roundover and the extra material keeps me from cutting into the side panels as I am doing the roundovers. Also – when faceting the thicker baffle keeps me from having to increase construction complexity by adding glue blocks in the corners to keep from exposing the interior of the cabinet to the outside world. If using 3/4" baffles on this build – just remember to add glue blocks to each corner to avoid that issue. 3/4 x 3/4 x 3" should be more than adequate.

If you have never cut facets before, the process can be intimidating. However, when you understand how it works it can be pretty straightforward. I use my cordless Dewalt circular saw and a straightedge to cut

mine. There are lots of instructions out there on how to use a straightedge as an accurate fence for your circular saws – I suggest doing a bit of Google Fu to find the tutorial that works best for you.

I cut the facets at a 45 degree angle, offset from front and side by an equal distance of 1-1/8". This is the same thickness as my baffle, and that is by design. I could have gone slightly deeper on the facets but chose the dimension I did to keep from digging too much in to the 3/4" side panels.

After cutting the facets, I did additional squaring up with my RO sander and also used said tool to apply a 1/4" radius to each of the facet edges. I can't prove it – but I believe it is necessary to do so.

Here is the baffle design:

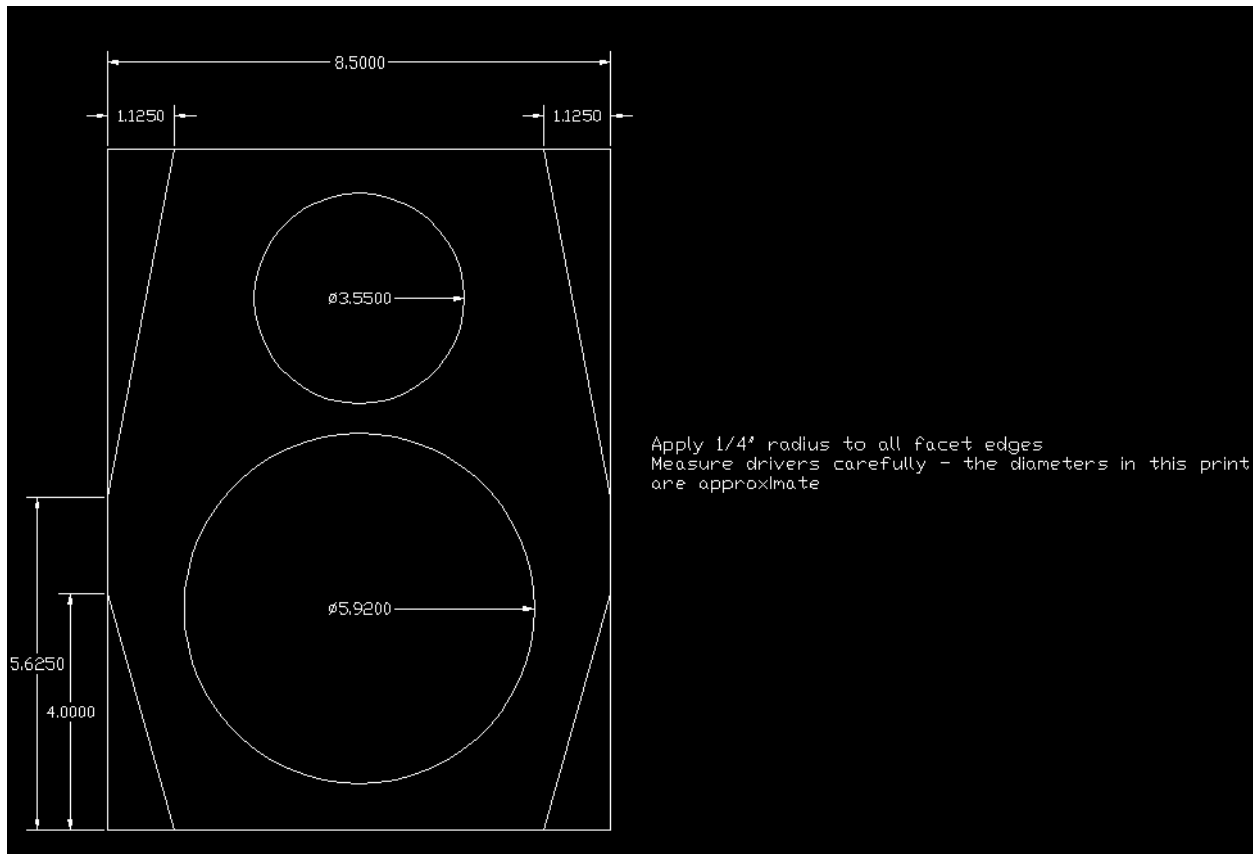

Measure your drivers carefully before cutting. I provided the dimensions of those circles as a general guideline on where to set your circle jig. I use the metric Jasper jig and will not go back to the standard. Also keep in mind mine uses the 92MM version – standard is 94MM. Measure your drivers, always.

As far as the rest of the baffle dimensions go, the overall outside dimensions of the cabinet are 8-1/2"W x 11-1/2"H x 10-1/2"D. Remember that includes my 1-1/8" thick baffle. Internal dimensions are 7"W x 8-1/2"D x 10"H. This yields a gross internal volume of 595 cubic inches or 0.34 cubic feet. By the time you add a 2" port, two drivers, and a side-to-side brace and crossovers, you can expect approximately 0.30-0.32 cubic feet. Hard to measure to the "T" how much net volume a speaker has without 3D modeling it. I do not know how to use modern 3D modeling software, so I guesstimate these things. Note: I ran a single brace side to side about 2/3 of the way up from the bottom of the cabinet.

Cabinet construction is straightforward on these. I used all butt joints and Titebond II. I clamp somewhat lightly and run brad nails and move on to the next joint.

My least favorite part of building speakers is machining the baffles. Just saying.

Here is a picture of the flat packs before glue up:



And here is a picture after assembly and machining showing what I meant by adding the  $\frac{1}{2}$ " radius:



After the cabinets were assembled and machined, I moved on to the process of measurement.

I am not going to go in to much detail on my measurement, crossover design, and voicing process in this writeup – there are a lot of resources out there that can cover all of that for you. Voicing is hard to capture in words, in any event. Plus, we all have our little secrets – favorite songs to listen to, certain passages, or whatever. I will tell one secret – on one of the Focal speaker demonstration disks is the recorded sound of a tape gun like the ones used to seal boxes. I have spent enough time in my life listening to those that I find it a good tool to use when listening. See, the problem with explaining any kind of voicing process is that your audience may not be familiar with what you are using. That makes voicing "secrets" fairly useless to anyone else.

Enough soapbox.

So that out of the way, here are the raw drivers measured on baffle:

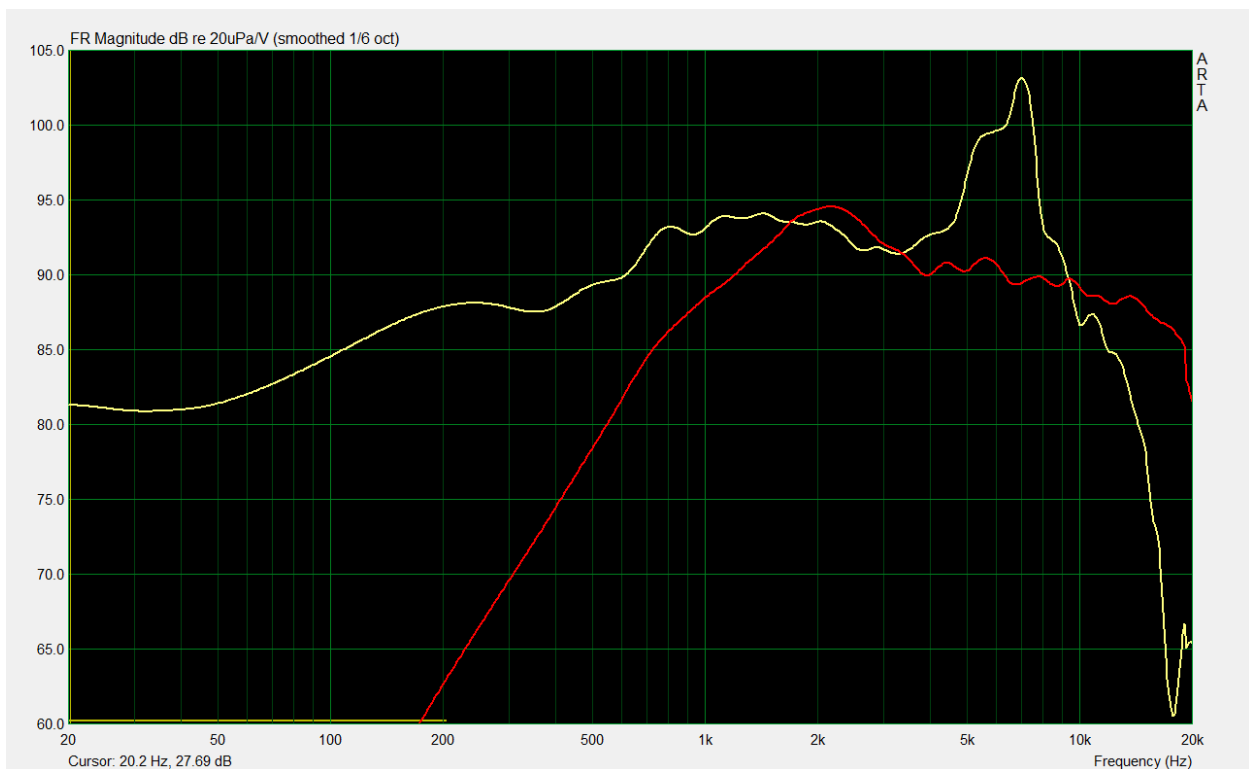

As can be seen, the woofer has a very dramatic breakup mode. The tweeter is fairly smooth, as is the woofer other than the breakup.

Do not let a breakup scare you away from using a woofer – they just require a little extra attention is all. In the distortion pictures below you will notice that the breakup does not really excite odd order distortion like some drivers do. I do not know what magic SB pulled off to get that result and am not really qualified in transducer design to even make an educated guess – I just trust the engineers to do their jobs, and it appears they did in this case.

The tweeter is not particularly sensitive, so it is probably a good thing I was planning on adding some series resistance to the woofer via multiple inductors.

Here is woofer distortion:

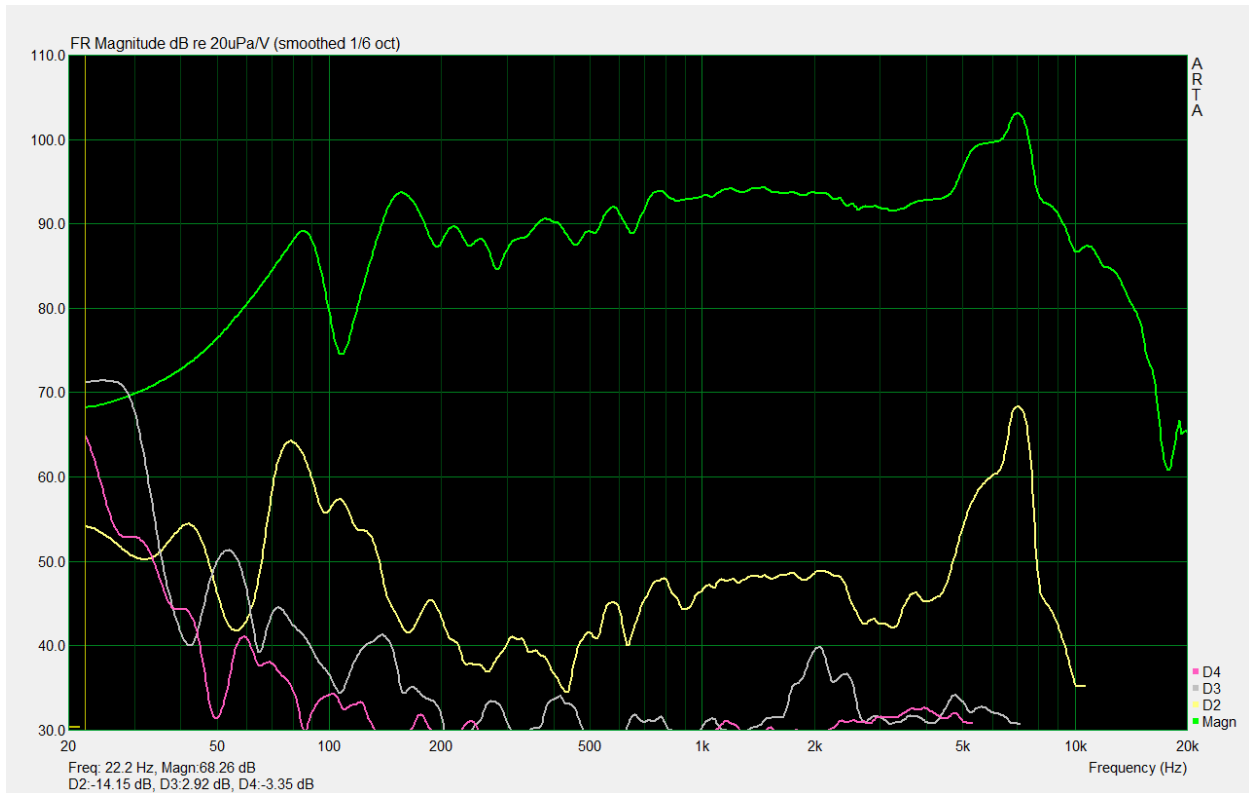

Here is tweeter distortion:

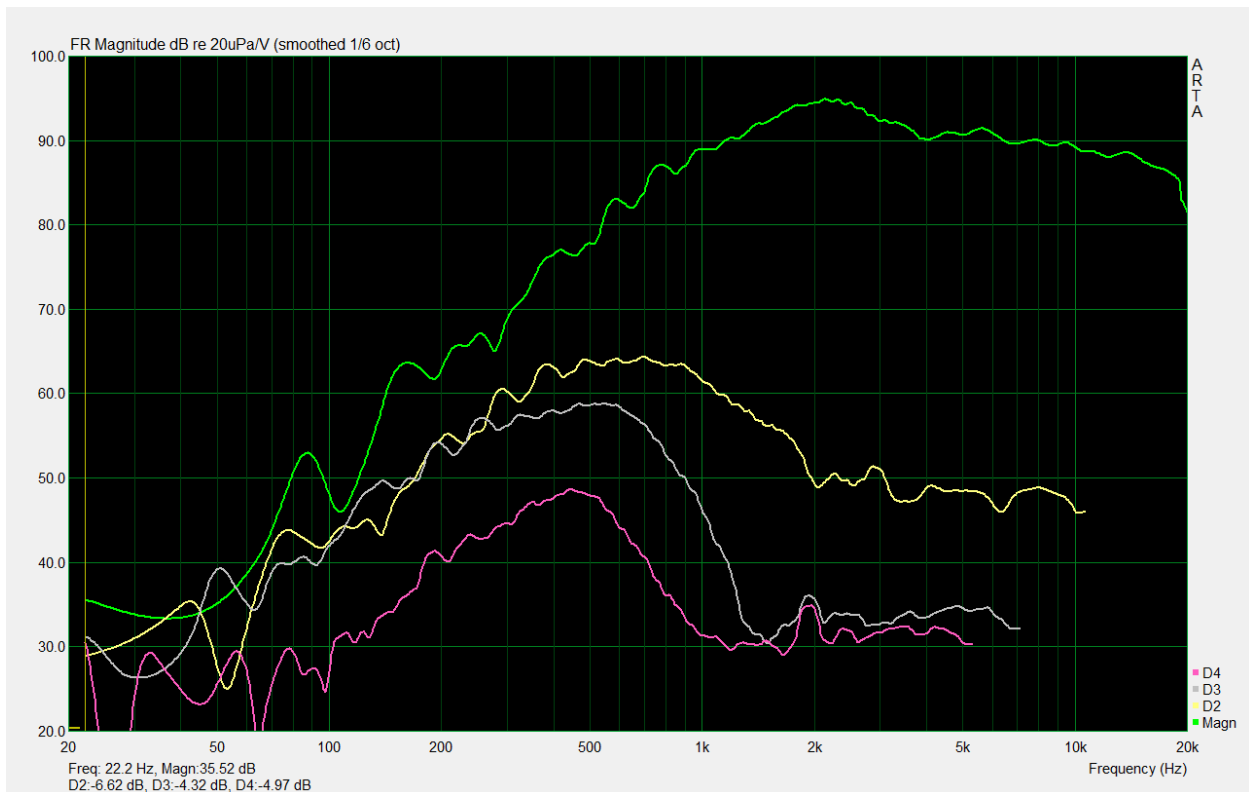



Both drivers are 2<sup>nd</sup> order dominant at these levels and many people claim 2<sup>nd</sup> order is “euphonic” in nature. They may be right.

...so after much time spent performing LMT (listen, measure, tweak) I ended up with this:

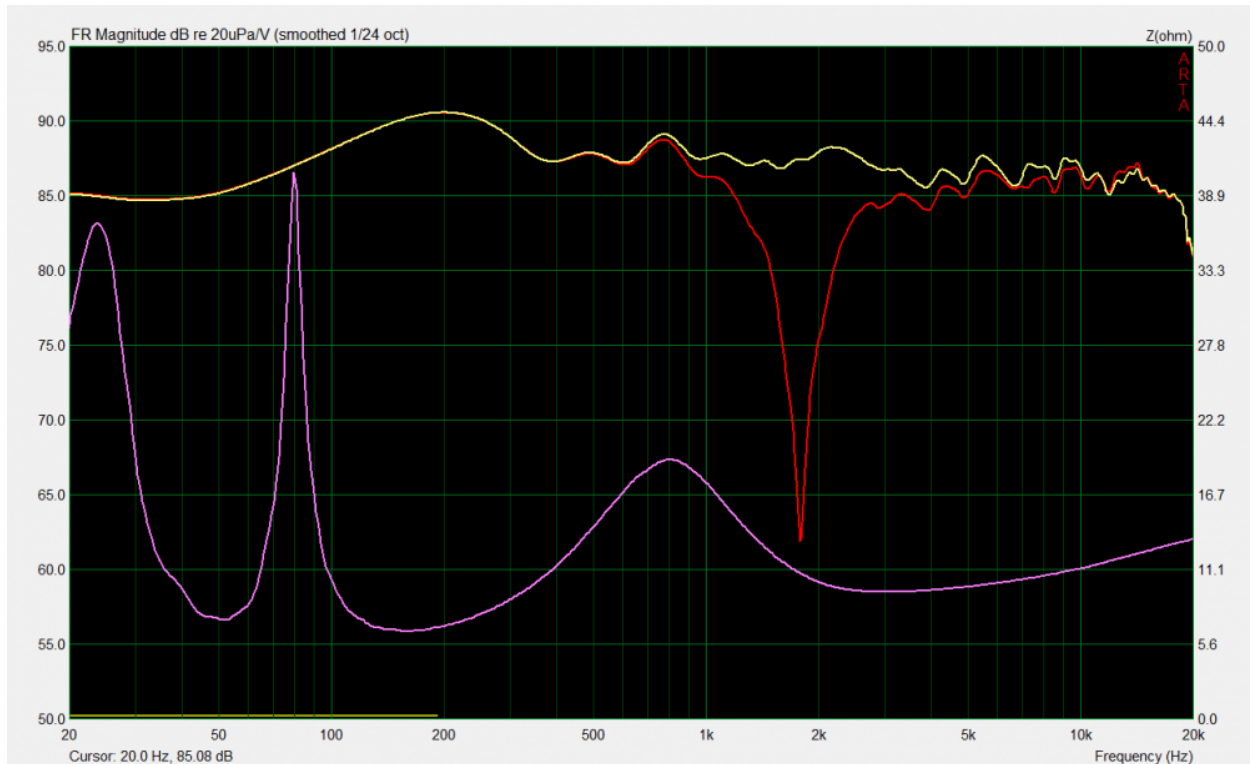

It exhibits a slight downward spectral tilt with a deep and relatively wide reverse null at the crossover point of 1800hz, and minimal phase interference above the crossover point.

It is a solid 8 ohm design with a very easy impedance load. It is less than +/- 30 degrees of phase angle everywhere I have control. In the bottom end it does dip past 45 degrees, however.

I am not afraid to throw components at a crossover under any circumstances. I do believe simpler is generally better, but the correct approach is to use exactly as many components as is necessary to hit a design goal – whatever that goal may be.

Sometimes I set a budget and work towards that. I inevitably accept some compromises on that approach, and that is OK given how budget some of *my* budget designs can end up being.

Sometimes I just want to challenge myself and use almost no components whatsoever. I have pulled off a few 4 component designs in my life and had reasonably good results.

This design uses quite a few for a 2-way. Basically it is a 3<sup>rd</sup> electrical on the woofer, and a 3<sup>rd</sup> electrical with a notch on the tweeter. “Fear not the notch” I always say. I added a capacitor across the terminals of the first woofer inductor to notch out the breakup.

Modeled woofer response:

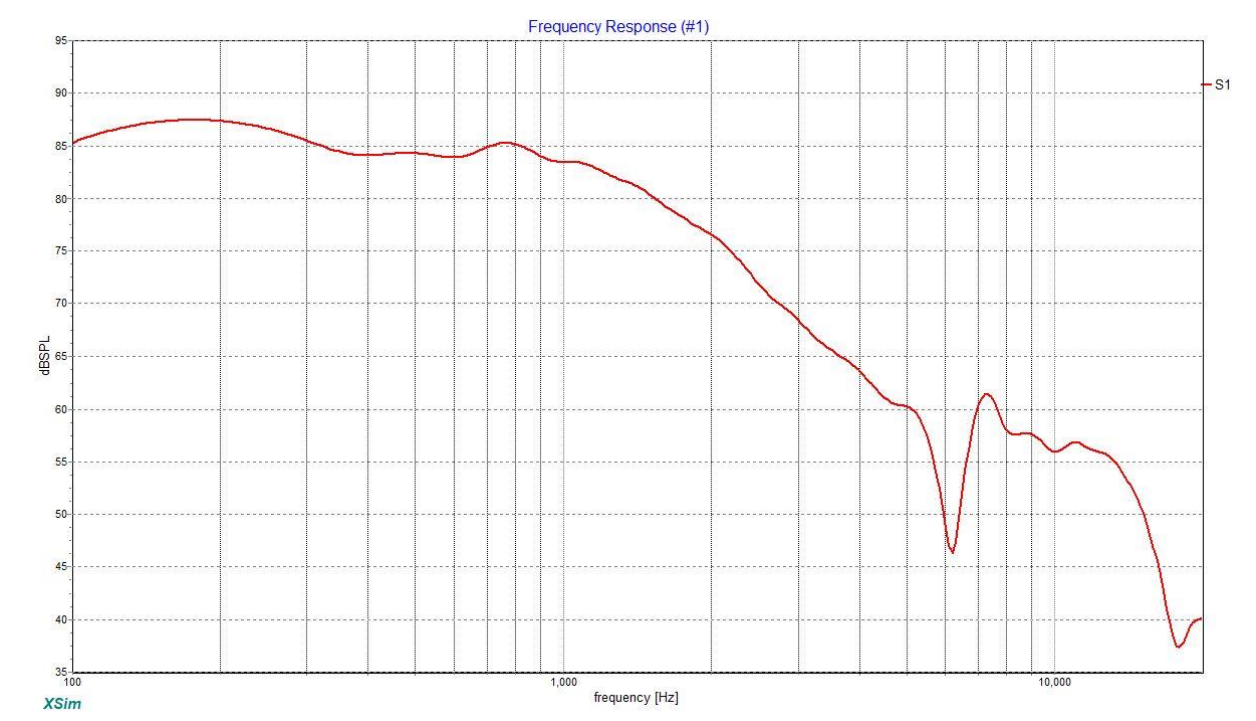

Modeled tweeter response:

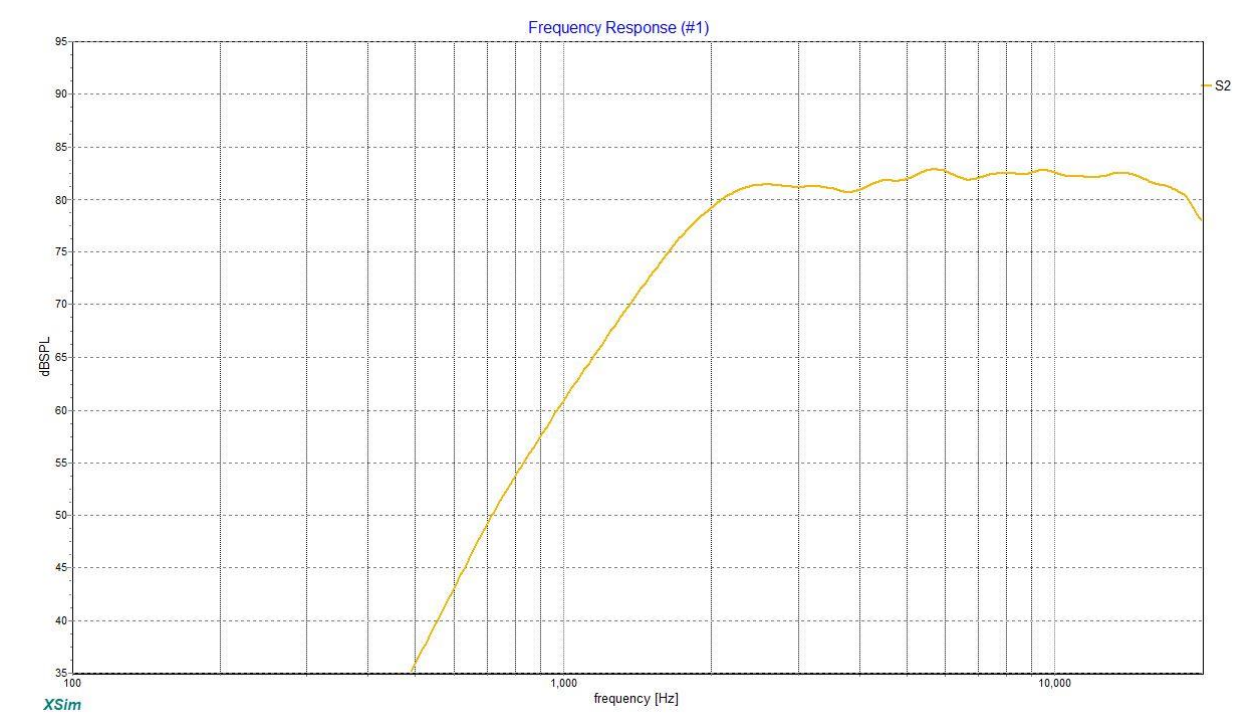

Both drivers ended up pretty well controlled; the woofer response irregularities around 6K are due to the notching effect of the little capacitor. I found it a necessary compromise.

Modeled impedance:

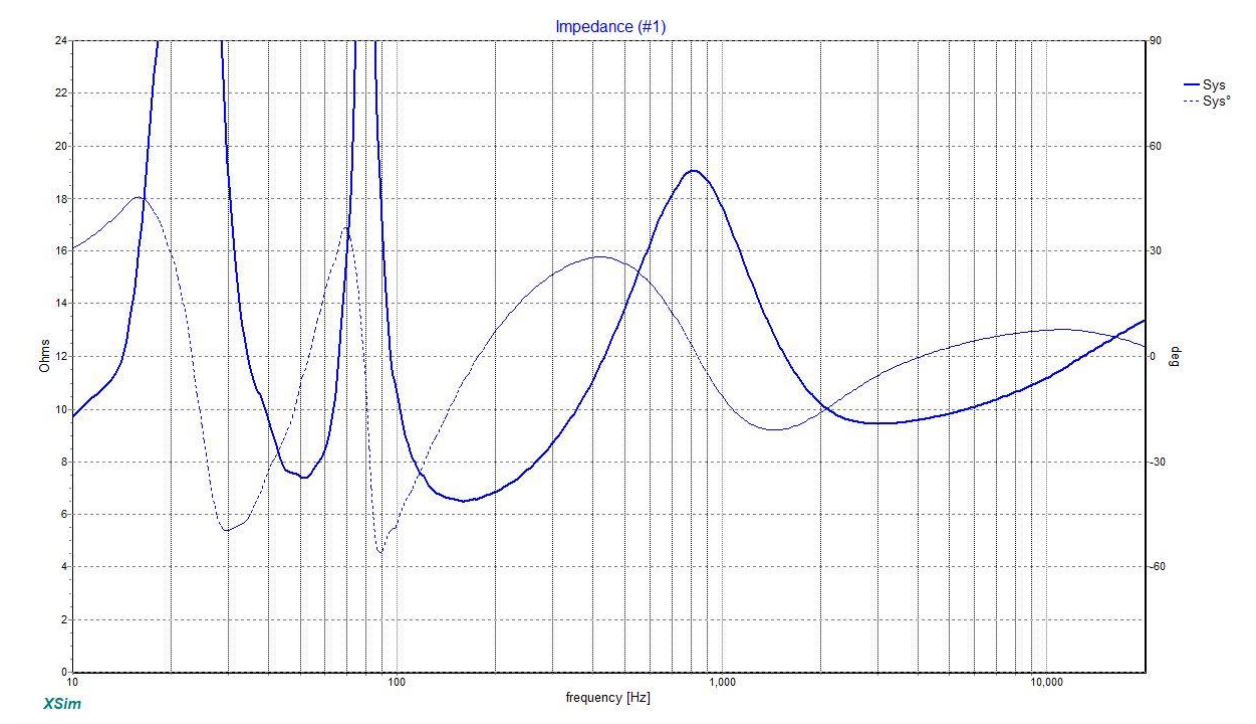

System distortion, SPL accurate at 1M:

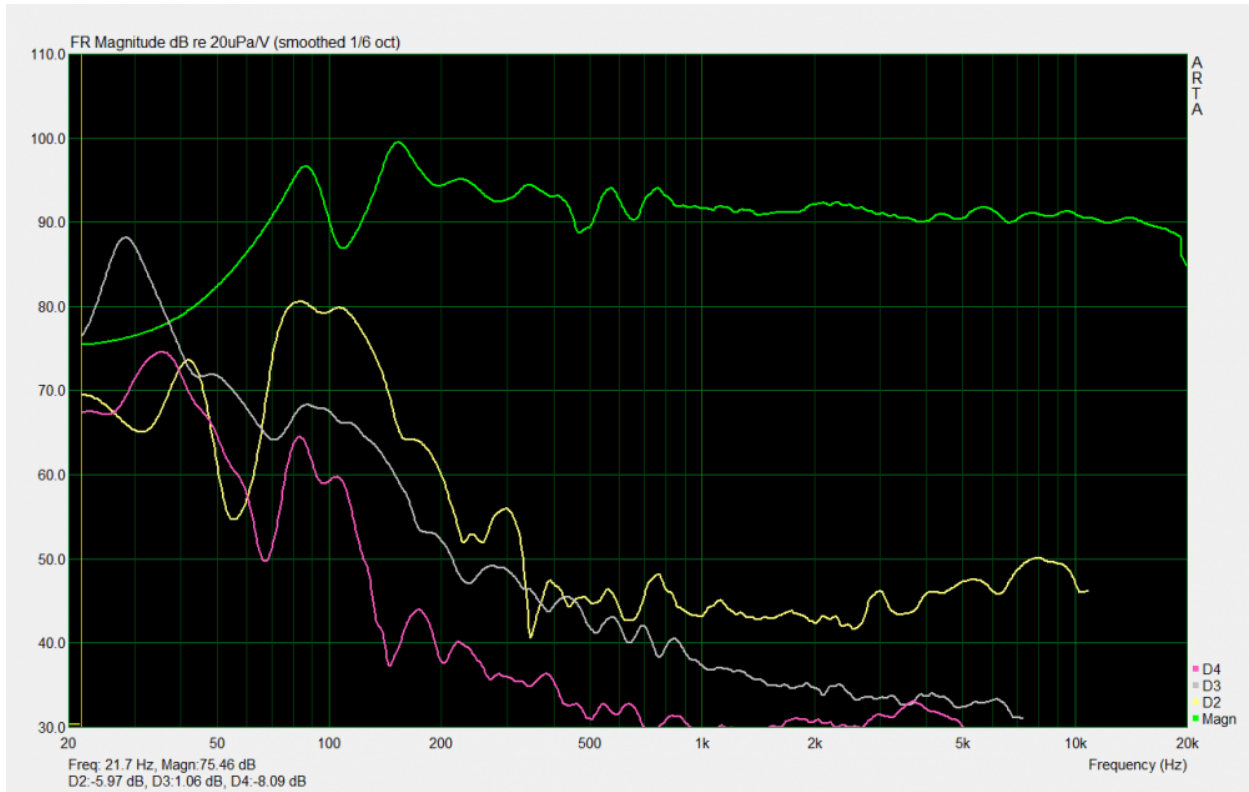

I did take polars but I rarely publish them. I may provide them offline on request, but if you have seen 4<sup>th</sup> LR polars in the past they would not be a surprise.

A picture from the LMT phase:



LMT (listen, measure, tweak) is the most enjoyable aspect of the hobby for me. I love hearing the music emerge as you dial it in and correlating that to the “squiggles” on my measurement PC. I look forward to this stage on every build – especially the first measurement of each driver, the big reveal as it were.

Crossover:

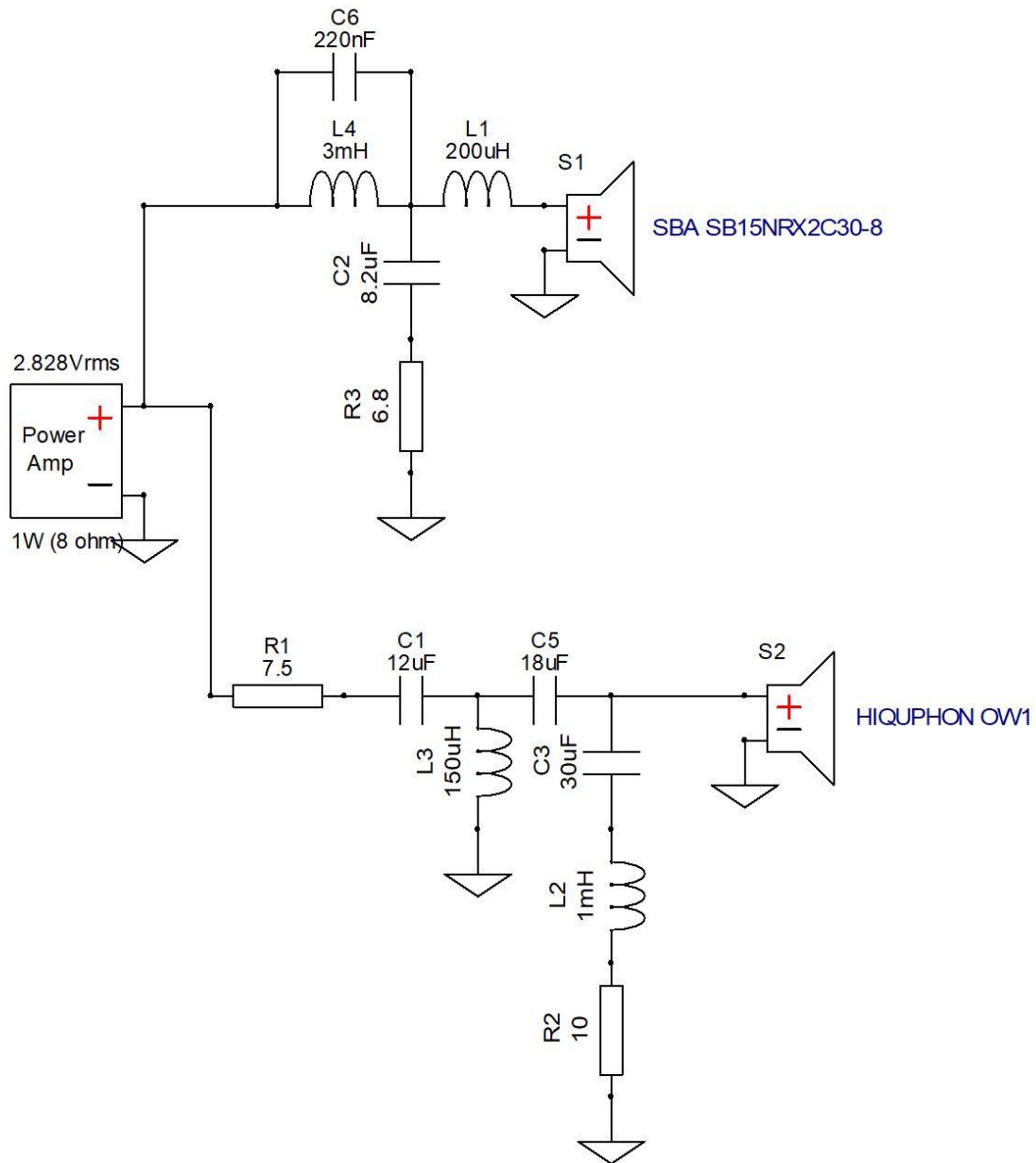

Madisound and Meniscus both carry everything needed for this design (well, Mad does not carry the tweeters), I recommend Meniscus because not only are they a great source for components – the owner himself comes to our various DIY events. That is a priceless contribution to the hobby in general.

Final tally for the components will come out to \$580 and up, depending on the capacitors you use. Personally, I use the Jantzen black caps but that is a preference based almost purely on aesthetics. Use whichever caps you can find in the specified values. I will say that substituting a 33uF for the 30uF may

alter the reverse null a bit but will otherwise serve the purpose. The rest should probably be sourced in the correct value.

The same advice goes for inductors and resistors. One reason to go with Meniscus is because they wind their own coils and if you need a special value they are willing to do it for you.

Listening time:



In this picture are a pair using a Dynavox 6.5" woofer and XT25BG60 in a waveguide, the Ersatz which use all AliExpress sourced components, behind Hermosa are the O'Ryan (tongue in cheek reference to Parts Express naming their latest kit after a very well-known design by a very well-known designer) sitting on top of the pair of 12" powered subs using GRS drivers and Dayton plate amps. There is also a guitar I don't play but it looks cool.

Perhaps most importantly, Mrs. JR gave me a thumbs up on this design. She has excellent ears and never pulls any punches when helping me evaluate things. I am grateful to have her around!

All in all, I am pretty pleased with how these turned out.

Hope to see some of you at our various DIY events!